

瞬态电压抑制二极管: SMF 系列

200W 表面贴装型



■ 特性

1. 玻璃钝化芯片
2. 响应时间快速
3. 钳位电压低
4. 漏电流小
5. 满足MSL1
6. JESD22-A114-B HBM: 15KV
7. JEDEC EIA/JESD22-C101F CDM: 500V
8. JEDEC EIA/JESD22-A115 MM: 400V
9. 符合IEC 61000-4-2 $\pm 30kV$ (接触)、 $\pm 30kV$ (空气)
10. 符合RoHS与无卤要求

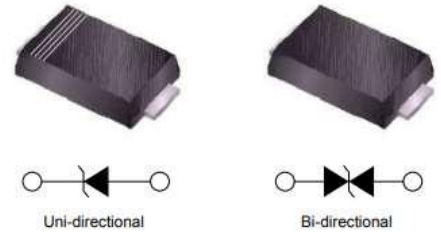

■ 用途

1. 通信设备
2. 计算机
3. 工业设备
4. 消费电子设备

■ 机械数据

1. 封装型式: SOD-123FL, 封装塑料符合防火等级UL94-V0
2. 镀锡引脚可焊性符合 MIL-STD-750, Method 2026.
3. 极性:有带状标示为阴极 (注:没有极性符号为双极性产品)

■ 编码规则

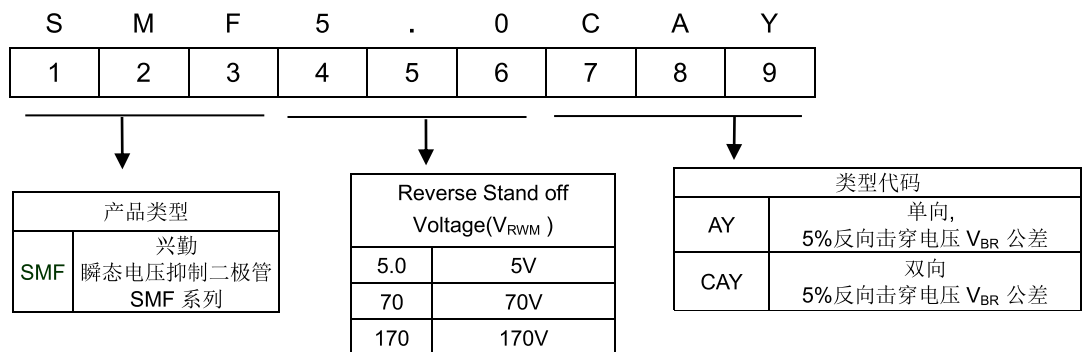

瞬态电压抑制二极管: SMF 系列

200W 表面贴装型



■ 结构与尺寸

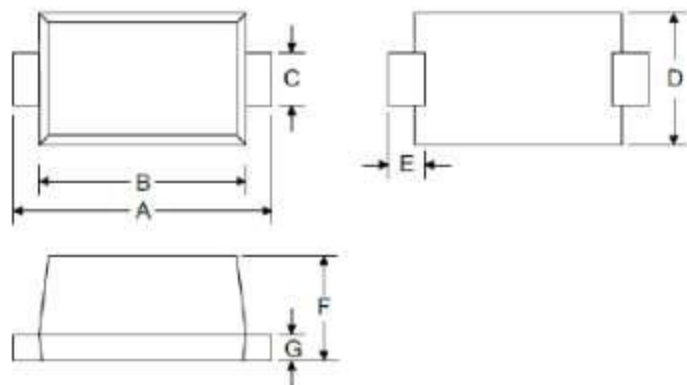

Symbol	Dimensions in millimeters	
	Min	Max
A	3.50	3.90
B	2.60	3.00
C	0.90	1.10
D	1.60	2.00
E	0.80 Typ.	
F	0.90	1.40
G	0.12	0.22

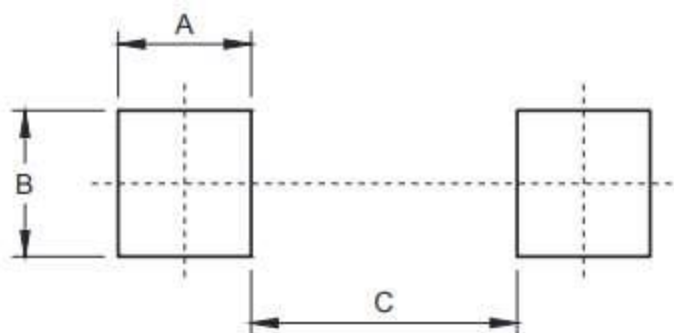

Symbol	Unit (mm)	Unit (inch)
A	1.0	0.039
B	1.1	0.043
C	2.0	0.079

■ 最大标称资料 (TA=25°C)

参数	代号	数值	单位
10/1000μs 波型峰值脉冲功耗(Note1, 2)	P _{PPM}	200	W
10/1000us 波型峰值脉冲电流.(Note1)	I _{PPM}	See next table	A
峰值正向浪涌电流 (Note 3)	I _{FSM}	20	A
稳态功耗 (T _L =50°C)	P _D	1	W
热阻 (结-环境)	R _{θJA}	220	°C/W
热阻 (结-引线)	R _{θJL}	100	°C/W
工作结温和存储温度范围	T _J , T _{STG}	-55 to +150	°C

注: 1.非重复性电流脉冲如图3, 及25°C以上减额曲线如图2。

2.安装在5.0 x 5.0mm的铜板上。

3.8.3ms 单半正弦波, 占空比最大为每分钟4个脉冲。

瞬态电压抑制二极管: SMF 系列

200W 表面贴装型



■ 电气特性 (T_A=25°C)

型号. (单向)	型号. (双向)	反向截止电压	反向击穿电压 V _{BR} @ I _T		测试 电流	最大限制 电压 V _C @ I _{pp}	最大脉冲峰值 电流	最大反向 漏电流 I _R @ V _{RWM}	印字	
		V _{RWM} (V)	Min(V)	Max(V)	I _T (mA)	V _C (V)	I _{pp} (A)	I _R (μA)	单向	双向
SMF5.0AY	SMF5.0CAY	5	6.4	7.07	10	9.2	21.74	400	AE	WE
SMF6.0AY	SMF6.0CAY	6	6.67	7.37	10	10.3	19.42	400	AG	WG
SMF6.5AY	SMF6.5CAY	6.5	7.22	7.98	10	11.2	17.86	250	AK	WK
SMF7.0AY	SMF7.0CAY	7	7.78	8.6	10	12	16.67	100	AM	WM
SMF7.5AY	SMF7.5CAY	7.5	8.33	9.21	1	12.9	15.51	50	AP	WP
SMF8.0AY	SMF8.0CAY	8	8.89	9.83	1	13.6	14.71	25	AR	WR
SMF8.5AY	SMF8.5CAY	8.5	9.44	10.4	1	14.4	13.89	10	AT	WT
SMF9.0AY	SMF9.0CAY	9	10	11.1	1	15.4	12.99	5	AV	WV
SMF10AY	SMF10CAY	10	11.1	12.3	1	17	11.77	1	AX	WX
SMF11AY	SMF11CAY	11	12.2	13.5	1	18.2	10.99	1	AZ	WZ
SMF12AY	SMF12CAY	12	13.3	14.7	1	19.9	10.05	1	BE	XE
SMF13AY	SMF13CAY	13	14.4	15.9	1	21.5	9.3	1	BG	XG
SMF14AY	SMF14CAY	14	15.6	17.2	1	23.2	8.62	1	BK	XK
SMF15AY	SMF15CAY	15	16.7	18.5	1	24.4	8.2	1	BM	XM
SMF16AY	SMF16CAY	16	17.8	19.7	1	26	7.69	1	BP	XP
SMF17AY	SMF17CAY	17	18.9	20.9	1	27.6	7.25	1	BR	XR
SMF18AY	SMF18CAY	18	20	22.1	1	29.2	6.85	1	BT	XT
SMF20AY	SMF20CAY	20	22.2	24.5	1	32.4	6.18	1	BV	XV
SMF22AY	SMF22CAY	22	24.4	26.9	1	35.5	5.64	1	BX	XX
SMF24AY	SMF24CAY	24	26.7	29.5	1	38.9	5.14	1	BZ	XZ
SMF26AY	SMF26CAY	26	28.9	31.9	1	42.1	4.75	1	CE	YE
SMF28AY	SMF28CAY	28	31.1	34.4	1	45.4	4.41	1	CG	YG
SMF30AY	SMF30CAY	30	33.3	36.8	1	48.4	4.13	1	CK	YK
SMF33AY	SMF33CAY	33	36.7	40.6	1	53.3	3.75	1	CM	YM
SMF36AY	SMF36CAY	36	40	44.2	1	58.1	3.44	1	CP	YP
SMF40AY	SMF40CAY	40	44.4	49.1	1	64.5	3.1	1	CR	YR
SMF43AY	SMF43CAY	43	47.8	52.8	1	69.4	2.88	1	CT	YT
SMF45AY	SMF45CAY	45	50	55.3	1	72.7	2.75	1	CV	YV
SMF48AY	SMF48CAY	48	53.3	58.9	1	77.4	2.59	1	CX	YX

瞬态电压抑制二极管: SMF 系列

200W 表面贴装型



■ 电气特性 (T_A=25°C)

型号. (单向)	型号. (双向)	反向截止电压	反向击穿电压 V _{BR} @ I _T		测试 电流	最大限制 电压 V _C @ I _{pp}	最大脉冲峰值 电流	最大反向 漏电流 I _R @ V _{RWM}	印字	
		V _{RWM} (V)	Min (V)	Max (V)	I _T (mA)	V _C (V)	I _{pp} (A)	I _R (μA)	单向	双向
SMF51AY	SMF51CAY	51	56.7	62.7	1	82.4	2.43	1	CZ	YZ
SMF54AY	SMF54CAY	54	60	66.3	1	87.1	2.3	1	RE	ZE
SMF58AY	SMF58CAY	58	64.4	71.2	1	93.6	2.14	1	RG	ZG
SMF60AY	SMF60CAY	60	66.7	73.7	1	96.8	2.07	1	RK	ZK
SMF64AY	SMF64CAY	64	71.1	78.6	1	103	1.94	1	RM	ZM
SMF70AY	SMF70CAY	70	77.8	86	1	113	1.77	1	RP	ZP
SMF75AY	SMF75CAY	75	83.3	92.1	1	121	1.66	1	RR	ZR
SMF78AY	SMF78CAY	78	86.7	95.8	1	126	1.59	1	RT	ZT
SMF85AY	SMF85CAY	85	94.4	104	1	137	1.46	1	RV	ZV
SMF90AY	SMF90CAY	90	100	111	1	146	1.37	1	RX	ZX
SMF100AY	SMF100CAY	100	111	123	1	162	1.24	1	RZ	ZZ
SMF110AY	SMF110CAY	110	122	135	1	177	1.13	1	SE	VE
SMF120AY	SMF120CAY	120	133	147	1	193	1.04	1	SG	VG
SMF130AY	SMF130CAY	130	144	159	1	209	0.96	1	SK	VK
SMF150AY	SMF150CAY	150	167	185	1	243	0.83	1	SM	VM
SMF160AY	SMF160CAY	160	178	197	1	259	0.77	1	SP	VP
SMF170AY	SMF170CAY	170	189	209	1	275	0.73	1	SR	VR
SMF180AY	SMF180CAY	180	201	222	1	292	0.68	1	ST	VT
SMF200AY	SMF200CAY	200	224	247	1	324	0.62	1	SV	VV

■ 特性曲线图 (T_A=25°C)

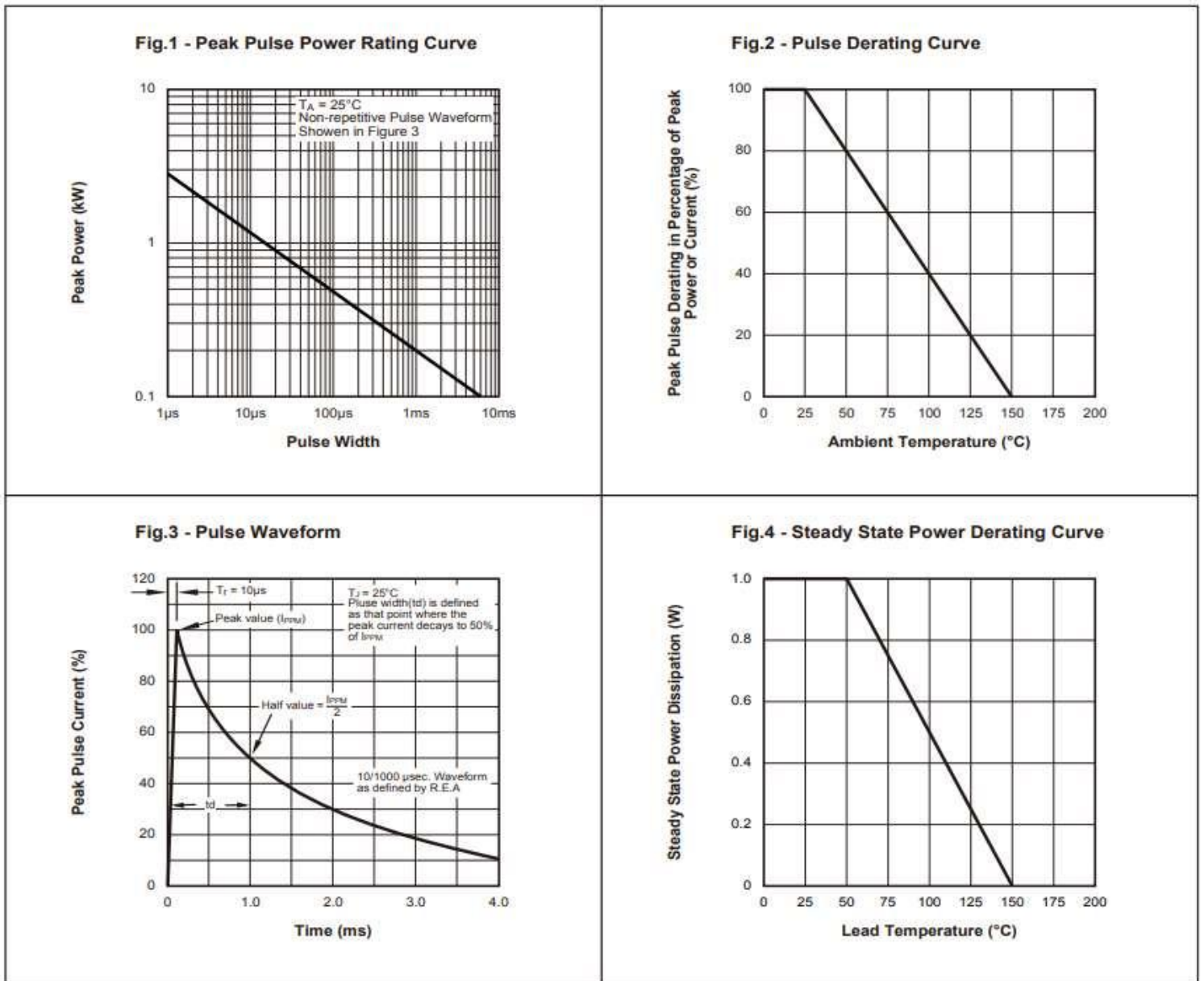

■ 推荐焊接条件

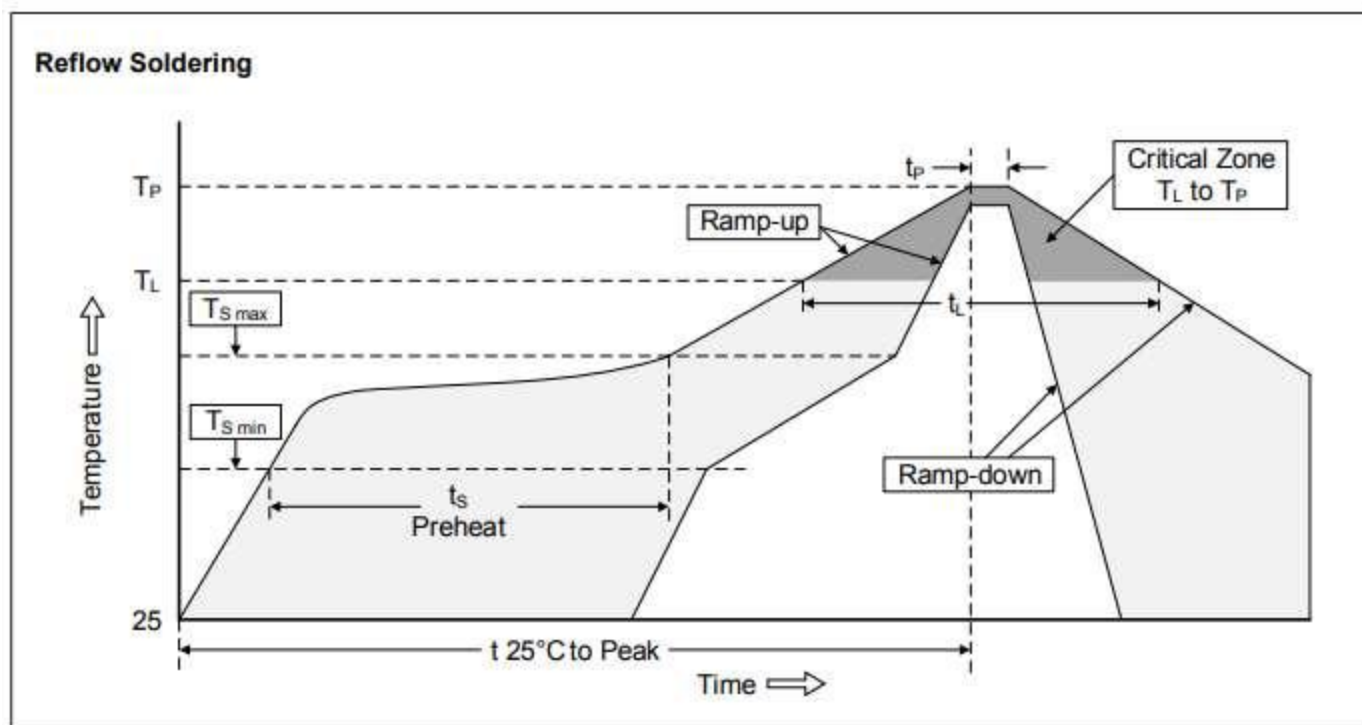
**Recommended Conditions**

Profile Feature	Pb-Free Assembly
Average ramp-up rate (T_L to T_P)	3°C/second max.
Preheat	
-Temperature Min ($T_{S\ min}$)	150°C
-Temperature Max ($T_{S\ max}$)	200°C
-Time (min to max) (t_s)	60-180 seconds
$T_{S\ max}$ to T_L	
-Ramp-up Rate	3°C/second max.
Time maintained above:	
-Temperature (T_L)	217°C
-Time (t_L)	60-150 seconds
Peak Temperature (T_P)	260°C
Time within 5°C of actual Peak Temperature (t_p)	20-40 seconds
Ramp-down Rate	6°C/second max.
Time 25°C to Peak Temperature	8 minutes max.

■ 包装

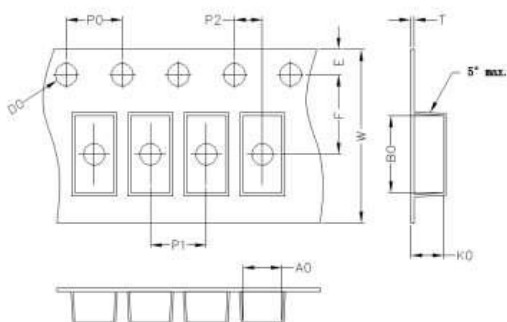

Symbol	A0	B0	K0	D0	E	F
Unit (mm)	2.15±0.1	3.95±0.1	13.5±0.1	1.5±0.1	1.75±0.1	3.5±0.1
Symbol	P0	P1	P2	T	W	
Unit (mm)	4.0±0.1	4.0±0.1	2.0±0.1	0.25±0.1	8.0±0.3	

■ 数量

系列	包装	数量	包装规范
SMF	Tape and reel	3000pcs / reel	EIA STD RS-481

■ 仓库存储条件

- 存储条件:
 1. 储存温度: -10℃~+40℃
 2. 相对湿度: ≤75%RH
 3. 不要将本产品存放在有腐蚀性气体或是阳光直接照射的环境中保管
- 存储期限: 1 年